

## GV-QFER12700 12MP H.265 Low Lux WDR IR Fisheye IP Camera



### Introduction

GV-QFER12700 is a 12 MP outdoor fisheye camera allowing you to monitor all angles of a location and can be installed to the ceiling or the wall. GV-QFER12700 supports H.265 video codec to achieve better compression ratio while maintaining high video quality at reduced network bandwidths. The live view of the camera can be accessed from up to 20 connections through the web interface. Equipped with automatic IR-cut filter and IR LEDs, GV-QFER12700 is capable of day and night surveillance. In addition, the embedded edge dewarping engine enables the camera to dewarp images by the camera itself rather than consuming resources from the backend devices.

### Key Features

- 1/1.7" progressive scan CMOS
- Quad streams from H.265, H.264 or MJPEG
- Up to 20 fps at 4000 x 3000
- On-edge dewarping up to 8 MP; software dewarping up to 12 MP
- Day and Night function (with removable IR-cut filter)
- Vandal resistance (IK10 for metal casing)
- Ingress protection (IP66)
- One sensor input and one alarm output
- Built-in micro SD card slot (SD/SDHC/SDXC/UHS-I, Class 10) for local storage
- Two-way audio
- DC 12V/ PoE (IEEE 802.af)
- Provides 360° and 180° panorama view
- Different angle of view accessible by multiple users at the same time
- Playback from any view angle and zoom level
- No mechanical moving parts
- Low lux enhancement
- 3D noise reduction
- Virtual PTZ function
- 12 languages on Web interface
- ONVIF Profile S / G/ T support
- Smart device app support

## Dimensions

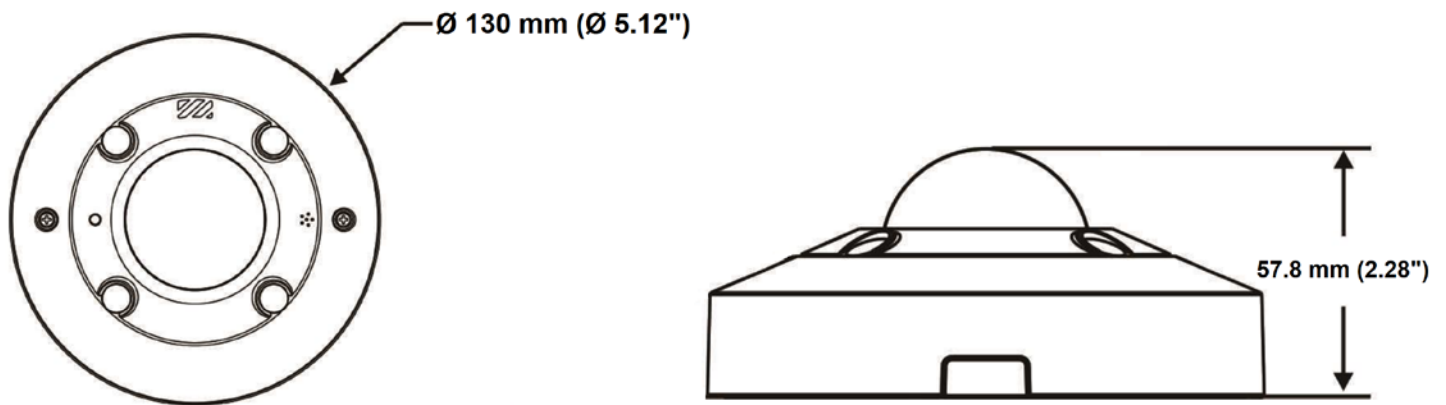

## Specifications

Camera		
Image Sensor	1/1.7" progressive scan CMOS	
Picture Elements	4000 (H) x 3000 (V)	
Minimum Illumination	Color	0.1 Lux
	B/W	0.01 Lux
	IR On	0 Lux
Shutter Speed	(1 ~ 1/10000 sec)	
White Balance	Auto / Manual	
S/N Ratio	52dB	
WDR	Yes	
Dynamic Range	77dB	
Optics Lens		
Megapixel	Yes	
Day/Night	Yes (with removable IR-cut filter)	
Lens Type	Fixed	
Focal Length	1.65 mm	
Maximum Aperture	F/2.8	
Image Format	1/1.7"	
Horizontal FOV	180°	
Operation	Focus	Fixed
	Zoom	Fixed
	Iris	Fixed
IR LED Quantity	4 IR LEDs	
Max. IR Distance	10 m (35 ft)	
Operation		
Video Compression	H.265, H.264, MJPEG	
Video Streaming	Quad streams from H.265, H.264 or MJPEG	
Frame Rate	20 fps at 4000 x 3000 (50/60 Hz) *The frame rate and the performance may vary depending on the number of connections and data bitrates (different scenes).	
Image Setting	Brightness, Contrast, Saturation, Sharpness, Hue, White Balance, Shutter Speed, D/N Sensitivity, Backlight Compensation, WDR, Denoise	
Audio Compression	G.711	
Audio Support	Two-way Audio (external microphone and speaker required)	
Sensor Input	1 input	
Sensor Output	1 output	

Video Resolution			
Software Dewarping	Main Stream	4000 x 3000 (Default), 1920 x 1080	
	Sub Stream	1024 x 768 (Default), 800 x 600, 640 x 480, 320 x 240	
	Third Stream (Closed by Default)	800 x 600, 720 x 576, 640 x 480, 352 x 288, 320 x 240	
	Quad Stream (Closed by Default)	800 x 600, 720 x 576, 640 x 480, 352 x 288, 320 x 240	
On-Edge Dewarping	Main Stream	Fisheye	2976 x 2976, 2048 x 2048, 2048 x 1536, 1920 x 1080
		Single View	2976 x 2976, 2048 x 2048, 2048 x 1536, 1920 x 1080
		Dual 180 Degree	2048 x 1536, 1920 x 1080
		Quad View	2976 x 2976, 2048 x 2048, 2048 x 1536, 1920 x 1080
	Sub Stream	Fisheye	2048 x 2048, 2048 x 1536, 1920 x 1080, 1600 x 1200, 1408 x 1408, 960 x 960, 960 x 720, 960 x 544
		Single View	2048 x 2048, 2048 x 1536, 1920 x 1080, 1600 x 1200, 1408 x 1408, 960 x 960, 960 x 720, 960 x 544
		Dual 180 Degree	2048 x 1536, 1920 x 1080, 1600 x 1200, 960 x 720, 960 x 544
		Quad View	2048 x 2048, 2048 x 1536, 1920 x 1080, 1600 x 1200, 1408 x 1408, 960 x 960, 960 x 720, 960 x 544
	Third Stream (Closed by Default)	Single View	480 x 360
	Network		
	Interface	10/100/1000 Ethernet	
	Protocol	ARP, IPv4/v6, TCP/IP, UDP, RTP, RTSP, HTTP, HTTPS, ICMP, FTP, SMTP, DHCP, PPPoE, UPnP, IGMP, SNMP, QoS, ONVIF (Profile S/G/T)	
Security Feature	<ul style="list-style-type: none"> <li>- No default ID and Password</li> <li>- 802.1x authentication</li> <li>- HTTPS with a SSL certificate stored in the camera</li> </ul>		
Mechanical			
Connectors	Power	DC Jack	
	Ethernet	RJ-45	
	Audio	1 In (external microphone) 1 Out (Stereo phone jack, 3.5 mm / 0.14")	
	Digital I/O	4-pin terminal block pitch 2.5 mm (0.1")	
	Local Storage	Micro SD card slot (SD/SDHC/SDXC/UHS-I, Class 10) Support recording to NAS	
General			
Operating Temperature	Start-up	-20°C ~ 70°C (-4°F ~ 158°F)	
	Operation	-30°C ~ 55°C (-22°F ~ 131°F)	
Humidity	10% to 90% (no condensation)		
Power Source	12V DC / PoE (IEEE 802.3af)		
Max. Power Consumption	12.95W		
Dimension	Ø 130 x 57.8 mm (Ø 5.12" x 2.28")		
Weight	565 g (1.25 lb)		
Ingress Protection	IP66		
Vandal Resistance	IK10		
Regulatory	CE, FCC, RoHS compliant		
Power over Ethernet			
PoE Standard	PoE (IEEE 802.3af Power over Ethernet / PD)		
PoE Power Supply Type	End-Span, Mid-Span		
PoE Power Output	Per Port 48 V DC, 320 mA, Max. 15.4 W		
Web Interface			
Installation Management	Web-based configuration		
Maintenance	Firmware upgrade through Web Browser or GV-IP Device Utility		
Language	Czech, English, French, German, Hungarian, Italian, Japanese, Portuguese, Russian, Spanish, Traditional Chinese, Simplified Chinese		

## Applications

Software Supported	GV-VMS (V17.4.1 / V18.2.1) *It is required to apply patch files to all the supported software. *Currently only GV-VMS, applied with the patches, supports GV-QFER12700.
Smart Device Access	GV-Eye for iOS and Android
Live Viewing	Internet Explorer, Non-IE browser (Edge, Chrome, Firefox, Safari), Mobile App *The non-IE browsers only support displaying live view with MJPEG.

### Note:









- Do not use clothes or any ordinary material to clean the camera cover since they may result in scratches.
- Mind the following when using an inserted memory card for recording:
  - Recorded data on the memory card can be damaged or lost if the data are accessed while the camera is under physical shock, power interruption, memory card detachment or when the memory card reaches the end of its lifespan. No guarantee is provided for such causes.
  - The stored data can be lost if the memory card is not accessed for a long period of time. Back up your data periodically if you seldom access the memory card.
  - Memory cards are expendable and their durability varies according to the conditions of the installed site and how they are used. Back up your data regularly and replace the memory card annually.
  - To avoid power outage, it is highly suggested to apply a battery backup (UPS).
  - For better performance, it is highly suggested to use micro SD card of MLC NAND flash, Class 10.
  - Replace the memory card when its read/write speed is lower than 6 MB/s or when the memory card is frequently undetected by the camera.
- Specifications are subject to change without notice.

## Packing List

- GV-QFER12700
- Self-Tapping Screw x 3
- Plastic Anchor x 3
- Torx Wrench
- Waterproof Rubber Set
- 4-Pin Terminal Block
- Download Guide
- Warranty Card

## Accessories

Model No.	Name		Details
GV-Mount100	Straight Tube and Junction Box Kit		Dimensions: 200 x 170 x 257.5 mm (7.9" x 6.7" x 10.1") Weight: 3.17 kg (6.99 lb)
GV-Mount101	Straight Tube Kit		Dimensions: 219 x 125 x 332 mm (8.6" x 4.9" x 13.1") Weight: 1.8 kg (3.97 lb)
GV-Mount200	Wall Pendant Mount		Dimensions: 225 x 140 x 250 mm (8.9" x 5.5" x 9.8") Weight: 900 g (1.98 lb) <b>Note:</b> To ensure the image quality, leave a distance of 1 M or more between the camera body and the wall.

GV-Mount203	Wall Mount and Junction Box		Dimensions: 315 x 195.5 x 225 mm (12.4 x 7.7 x 8.9") Weight: 2.95 kg (6.5 lb)
GV-Mount206-1	Wall Box Mount		Dimensions: 126.5 x 211.3 x 176.85 mm / 5 x 8.3 x 6.96" Weight: 1.06 kg (2.33 lb)
GV-Mount208-2	Swan Neck Mount		Dimensions: 1043 x 519 x 256 mm (41.06" x 20.43" x 10.08") Weight 10.5 kg (23.15 lb)
GV-Mount702	Extension Tube		Four options are available. Dimensions: Ø 5.4 x 10 or 20 or 30 or 50 cm (Ø 2.1" x 3.9" or 7.9" or 11.8" or 19.7") Weight: 180 g or 390 g or 550 g or 800 g (0.4 lb or 0.86 lb or 1.21 lb or 1.76 lb)
GV-Mount903-2	Dome Housing Mount		Dimensions: Ø 185.5 x 165.3 mm (Ø 7.3" x 6.5") Weight: 1.03 kg (2.27lb)
GV-Mount904-2	Tilting Wall Mount Bracket		Dimensions: Ø 159.1 x 40.5 mm (Ø 6.3 x 1.6") Weight: 0.48 kg (1.05 lb)
GV-Mount912-1	Power Box Mount Bracket		Dimensions: Ø 130 mm (Ø 5.1") Weight: 180 g (0.4 lb)
GV-Mount919	In-Ceiling Mount		Dimensions: Ø 189 x 75.9 mm (Ø 7.44 x 2.98") Weight: 525 g (1.15 lb)
GV-PA191	Power over Ethernet (PoE) Adapter		GV-PA191 is a Power over Ethernet (PoE) adapter designed to provide power to the IP device through a single Ethernet cable.
<a href="#">GV-PoE Switch</a>	GV-PoE Switch is designed to provide power along with network connection for IP devices. GV-PoE Switch is available in various models with different numbers and types of ports.		
Power Adapter	Contact our sales representatives for the countries and areas supported.		