

## GV-EFER3700 3MP H.265 Super Low Lux WDR Pro IR Fisheye Rugged IP Camera



### Introduction

GV-EFER3700 is a 3 MP outdoor fisheye camera that allows you to monitor all angles of a location and it can be installed to the ceiling, wall, wall corner and the pole. Equipped with automatic IR-cut filter and IR LEDs, GV-EFER3700 is capable of day and night surveillance. The camera's distorted hemispherical image can be converted into a conventional rectilinear projection. Without installing any software, you can watch live view and utilize functions such as video recording, privacy mask, and alert notification through the Web interface. In addition, the camera seamlessly integrates with the GV-DVR / NVR / VMS, providing advanced monitoring and video management features.

The camera can support H.265 video codec to achieve better compression ratio while maintaining high picture quality at reduced network bandwidths. GV-EFER3700 is capable of providing a color live view not only in near darkness but also under contrasting light intensities with its super low lux CMOS image sensor and WDR pro.

### Key Features

- 1/2.8" progressive scan super low lux CMOS
  - Triple streams from H.265, H.264 and MJPEG
  - Up to 30 fps at 2048 x1536
  - Day and night (with removable IR-cut filter)
  - Intelligent IR
  - Vandal resistance (IK8)
  - Ingress protection (IP67)
  - 12V DC / PoE (IEEE 802.3af)
  - Built-in micro SD card slot (SD/SDHC/SDXC/UHS-I) for local storage
  - One sensor input and alarm output
  - [Digital Object Tracking](#)
  - Provides 360° and 180° panorama view
  - Different angle of view accessible by multiple users at the same time
  - Playback from any view angle and zoom level
  - No mechanical moving parts
  - Two-way audio
  - Wide Dynamic Range Pro (WDR Pro)
  - Low lux enhancement
  - 3D noise reduction
  - Smart streaming
  - Tampering alarm
  - Virtual PTZ function
  - Auto Pan function
  - Privacy mask
  - Visual automation
  - Text overlay
  - 31 languages on Web interface
  - ONVIF (Profile S) conformant
  - Recording assigned by GV-Edge Recording Manager ([Windows version](#))
- \* No Memory Card Slot & local storage function for Argentina.
- \* Smart streaming requires GV-DVR / NVR V8.7.0, GV-VMS V16.10.3 or later software versions.

Photos

Fisheye Source Image



Single View



2 x 180° View



360° View



Quad View



## Dimensions

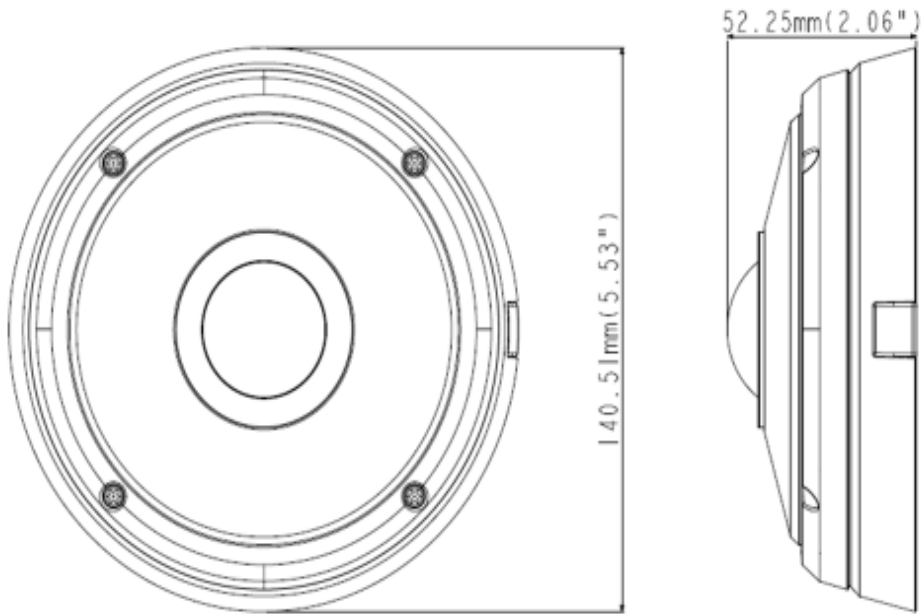

## Specifications

Camera		GV-EFER3700
Image Sensor		1/2.8" progressive scan super low lux CMOS
Picture Elements		2048 (H) x 1536 (V)
Minimum Illumination	Color	0.001 Lux
	B/W	0.001 Lux
	IR On	0 Lux
Shutter Speed		Automatic, Manual (1/5 ~ 1/16000 sec.)
White Balance		Automatic, Manual (2800K ~ 8500K)
Gain Control		Automatic
S/N Ratio		54 dB
WDR		WDR Pro
Dynamic Range		Up to 120 dB
Optics Lens		
Megapixel		Yes
Day/Night		Yes (with removable IR-cut filter)
Lens Type		Fixed
Focal Length		1.24 mm
Maximum Aperture		F/1.8
Mount		M12
Image Format		1/3"
Horizontal FOV		185°
Operation	Focus	Fixed
	Zoom	Fixed
	Iris	Fixed
IR LED Quantity		3 IR LEDs
Max. IR Distance		20 m (65.61 ft)
Operation		
Video Compression		H.265, H.264, MJPEG
Video Streaming		Stream 1 from H.265 or H.264 Stream 2 from H.265, H.264 or MJPEG Stream 3 from H.265, H.264 or MJPEG

Frame Rate	50Hz: 25 fps at 2048 x 1536, 25 fps at 1440 x 1376 60Hz: 30 fps at 2048 x 1536, 30 fps at 1440 x 1376 *The frame rate and the performance may vary depending on the number of connections and data bitrates (different scenes).	
Image Setting	Brightness, Contrast, Saturation, Sharpness, Gamma, White Balance, Flicker-less, Image Orientation, Shutter Speed, D/N Sensitivity, Backlight Compensation, WDR, Defog, Low Lux Enhancement, Denoise, Metering	
Audio Compression	G.711, AAC (Optional)	
Audio Support	Two-way Audio (external microphone and speaker required)	
Sensor Input	1 input (Dry Contact)	
Sensor Output	1 digital output (200mA 5V DC)	
<b>Video Resolution</b>		
Main Stream	4:3	2048 x 1536 (Default)
	20:19	1440 x 1376, 1280 x 1200
Sub Stream	4:3	640 x 480 (Default)
	20:19	640 x 608
Third Stream (Closed by Default)	4:3	640 x 480
	20:19	640 x 608
<b>Network</b>		
Interface	10/100 Ethernet	
Protocol	DHCP, DNS, DynDNS, FTP, HTTP, HTTPS, ICMP, IPv4, IPv6, Multicast, NTP, ONVIF (Profile S), QoS (DSCP), RTP, RTCP, RTSP, SNMP, SMTP, SSL, TCP/IP, UDP, UPnP, 3GPP/ISMA	
Security Feature	<ul style="list-style-type: none"> <li>- No default ID and Password</li> <li>- 802.1x authentication</li> <li>- HTTPS with a SSL certificate stored in the camera</li> <li>- 256-bit AES encryption (requires firmware V1.14 or later working with GV-VMS V18.1 or later)</li> </ul>	
<b>Mechanical</b>		
Temperature Detector	Yes	
Connectors	Power	2-pin terminal block (DC 12V, 1.25A), PoE
	Ethernet	Ethernet (10/100 Base-T), RJ-45
	Audio	1 In (External microphone, 3.5 mm / 0.14") 1 Out (Stereo phone jack, 3.5 mm / 0.14")
	Digital I/O	3-pin terminal block, pitch 2.5 mm (0.1")
	Local Storage	Micro SD card slot (SD/SDHC/SDXC/UHS-I, Class 10) *UHS-II card type is not supported.
LED Indicator	2 LEDs: Power / Status	
<b>General</b>		
Operating Temperature	Start-up	-20°C ~ 50°C (-4°F ~ 122°F)
	Operation	-30°C ~ 50°C (-22°F ~ 122°F)
Humidity	10% to 90% (no condensation)	
Power Source	12V DC / PoE (IEEE 802.3af)	
Max. Power Consumption	10.5 W	
Dimension	Ø 140.5 x 52.2 mm m (5.5" x 2.05")	
Weight	670 g (1.47 lb)	
Ingress Protection	IP67	
Vandal Resistance	IK8	
Regulatory	CE, FCC, RCM, LVD, RoHS compliant	
<b>Power over Ethernet</b>		
PoE Standard	PoE (IEEE 802.3af Power over Ethernet / PD)	
PoE Power Supply Type	End-Span, Mid-Span	
PoE Power Output	Per Port 48V DC, 350mA. Max. 15.4 watts	



Web Interface	
Installation Management	Web-based configuration
Maintenance	Firmware upgrade through Web Browser or Utility
Access from Web Browser	Camera Live View, Video Recording, Change Video Quality, Bandwidth Control, Image Snapshot, Audio, Picture in Picture, Picture and Picture, Privacy Mask, Visual Automation, Tampering Alarm, Text Overlay
Language	Arabic / Bulgarian / Czech / Danish / Dutch / English / Finnish / French / German / Greek / Hebrew / Hungarian / Indonesian / Italian / Japanese / Lithuanian / Norwegian / Persian / Polish / Portuguese / Romanian / Russian / Serbian / Simplified Chinese / Slovakian / Slovenian / Spanish / Swedish / Thai / Traditional Chinese / Turkish
Applications	
Software Supported	GV-DVR / NVR (V8.7.3.0), GV-VMS (V16.10.3.0), GV-Edge Recording Manager (V1.2.0.0), GV-Center V2 (V16.10.0.0), GV-Recording Server (V1.3.0.0), GV-Redundant / Failover Server (V1.1.0.0)
Smart Device Access	GV-Eye for iOS and Android
Remote Live Viewing	Browser (IE, Chrome, Firefox, Safari), Mobile App
CMS Server Support	GV-Control Center, GV-Center V2, GV-Vital Sign Monitor

**Note:**







1. It is required to apply patch files to all the supported software.
2. Do not use clothes or any ordinary material to clean the camera cover since they may result in scratches.
3. Mind the following when using an inserted memory card for recording:
  - Recorded data on the memory card can be damaged or lost if the data are accessed while the camera is under physical shock, power interruption, memory card detachment or when the memory card reaches the end of its lifespan. No guarantee is provided for such causes.
  - The stored data can be lost if the memory card is not accessed for a long period of time. Back up your data periodically if you seldom access the memory card.
  - Memory cards are expendable and their durability varies according to the conditions of the installed site and how they are used. Back up your data regularly and replace the memory card annually.
  - To avoid power outage, it is highly suggested to apply a battery backup (UPS).
  - For better performance, it is highly suggested to use Micro SD card of MLC NAND flash, Class 10.
  - Replace the memory card when its read/write speed is lower than 6 MB/s or when the memory card is frequently undetected by the camera.
4. Specifications are subject to change without notice.



**Packing List**

- |                         |                           |
|-------------------------|---------------------------|
| 1. H.265 Fisheye Camera | 6. Terminal Block (3-pin) |
| 2. Torx Wrench          | 7. Installation Sticker   |
| 3. Screw x 2            | 8. Download Guide         |
| 4. Screw Anchor x 2     | 9. Warranty Card          |
| 5. Silica Gel Bag x 2   |                           |

**Accessories**

Model No.	Name	Details
GV-Mount100	Straight Tube and Junction Box Kit	<div style="text-align: center;">  </div> Dimensions: 200 x 170 x 257.5 mm (7.9" x 6.7" x 10.1") Weight: 3.17 kg (6.99 lb)

Model No.	Name		Details
GV-Mount101	Straight Tube Kit		<p>Dimensions: 219 x 125 x 332 mm (8.6" x 4.9" x 13.1")</p> <p>Weight: 1.8 kg (3.97 lb)</p>
GV-Mount200	Wall Pendant Tube		<p>Dimensions: 225 x 140 x 250 mm (8.9" x 5.5" x 9.8")</p> <p>Weight: 900 g (1.98 lb)</p> <p>Note: To ensure the image quality, leave a distance of 1 M or more between the camera body and the wall.</p>
GV-Mount206	Wall Mount Bracket Kit		<p>Dimensions: 126.5 x 211.3 x 176.85 mm / 5 x 8.3 x 6.96 in (L x W x diameter)</p> <p>Weight: 0.93 kg / 2.06 lb</p> <p>Note: To ensure the image quality, leave a distance of 1 M or more between the camera body and the wall.</p>
GV-Mount208-2	Swan Neck Mount		<p>Dimensions: 1043 x 519 x 256 mm / 41.06 x 20.43 x 10.08 in</p> <p>Weight: 10.5 kg / 23.15 lb</p>
GV-Mount702	Extension Tube		<p>Four options are available.</p> <p>Dimensions: <math>\varnothing</math> 5.4 x 10 or 20 or 30 or 50 cm (<math>\varnothing</math> 2.1" x 3.9" or 7.9" or 11.8" or 19.7")</p> <p>Weight: 180 g or 390 g or 550 g or 800 g (0.4 lb or 0.86 lb or 1.21 lb or 1.76 lb)</p>
GV-Mount901-1	Fisheye Dome Housing		<p>Dimensions: <math>\varnothing</math> 185.5 x 165.3 mm (<math>\varnothing</math> 7.3" x 6.5")</p> <p>Weight: 900 g (1.98 lb)</p>
GV-Mount903-1	Fisheye Dome Housing		<p>Dimensions: <math>\varnothing</math> 185.5 x 165.3 mm (<math>\varnothing</math> 7.3" x 6.5")</p> <p>Weight: 900 g (1.98 lb)</p>

Model No.	Name	Details
GV-Mount904-1	Tilting Wall Mount Bracket	 <p>Dimensions: Ø 159.1 x 40.5 mm (Ø 6.3" x 1.6") Weight: 350 g (0.77 lb)</p>
GV-Mount913	Power Box Mount Bracket	 <p>Dimensions: Ø 146 x 7.5 mm (Ø 5.7" x 0.3") Weight: 180 g (0.4 lb)</p>
GV-Relay V2		 <p>The GV-Relay V2 is designed to expand the voltage load of GV IP devices. It provides 4 relay outputs, and each can be set as normally open (NO) or normally closed (NC) independently as per your requirement.</p>
GV-POE Switch		The GV-POE Switch is designed to provide power along with network connection for IP devices. The GV-POE Switch is available in various models with different numbers and types of ports.
Power Adaptor		Contact our sales representatives for the countries and areas supported.