

## GV-BL3700 3MP H.265 Super Low Lux WDR Pro IR Bullet IP Camera



- 1/2.8" progressive super scan low lux CMOS
- Min. illumination at 0.01 lux
- Dual streams from H.265, H.264, and MJPEG
- Up to 30 fps at 2048 x 1536
- P-iris lens for auto iris control
- Vandal resistance (IK10 for metal casing)
- Ingress protection (IP67)
- Day/Night function (with removable IR-cut filter)
- Intelligent IR
- IR distance up to 30 m (98.4 ft)
- Two-way audio
- One alarm input and sensor output
- Built-in micro SD card slot (SD/SDHC/SDXC/UHS-I) for local storage
- DC 12V / PoE (IEEE 802.3af)
- Wide Dynamic Range Pro (WDR Pro)
- Smart streaming
- Defog
- Text overlay
- Tampering alarm
- 3D noise reduction
- IP address filtering
- Recording assigned by GV-Edge Recording Manager (Windows & Mac)
- Supports iPhone, iPad, Android & 3GPP
- 31 languages on Web interface
- ONVIF (Profile S) conformant
- \* No Memory Card Slot & local storage function for Argentina.
- \* Smart streaming requires either GV-DVR / NVR V8.7.0 or GV-VMS V16.10.3.

### Introduction

GV-BL3700 is an outdoor camera for optimal day and night surveillance. The camera can support H.265 video codec to achieve better compression ratio while maintaining high quality pictures at reduced network bandwidths. For night operations, the camera allows up to 30 m (98.4 ft) IR effective distance. The camera is capable of not only providing a color live view in near darkness but also under contrasting light intensities using super low lux CMOS image sensor, and WDR pro. It also uses P-iris to produce images with better clarity and contrast.

### Active Tampering Alarm

Tampered



Focus Change

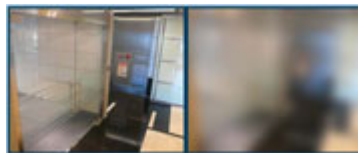

Camera Shift

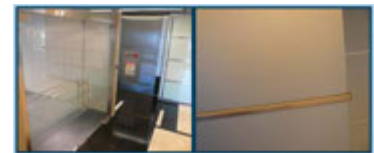

## Dimensions

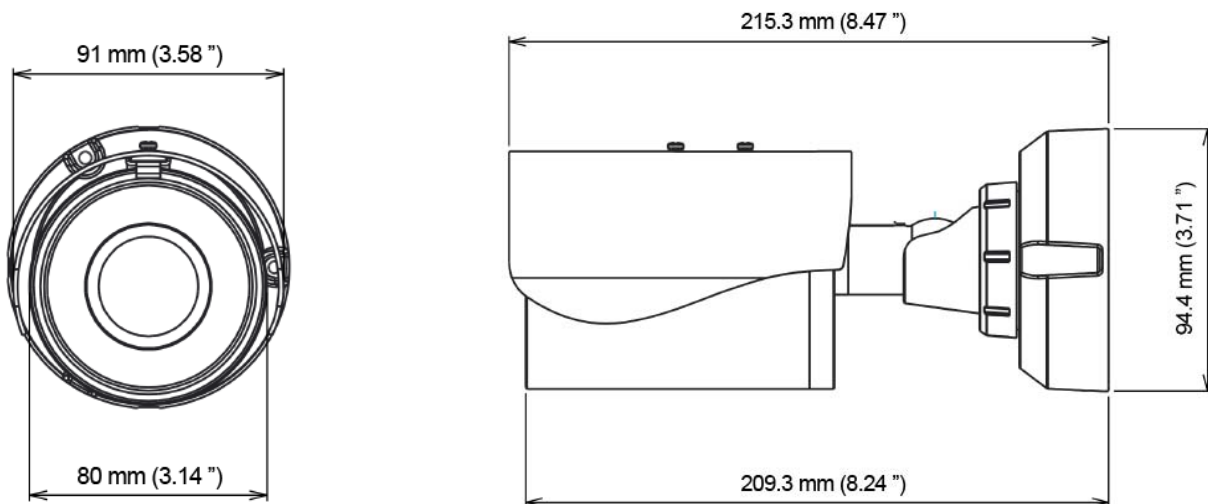

## Specifications

Camera		
Image Sensor	1/2.8" progressive scan CMOS	
Picture Elements	2048 (H) x 1536 (V)	
Minimum Illumination	Color	0.01 Lux
	B/W	0.01 Lux
	IR ON	0 Lux
Shutter Speed	Automatic, Manual (1/5 ~ 1/8000 sec.)	
White Balance	Automatic, Manual (2800K ~ 8500K)	
Gain Control	Automatic	
S/N Ratio	54 dB	
WDR Pro	Yes	
Dynamic Range	Up to 120dB	
BLC	Yes	
Lens		
Megapixel	Yes	
Focal Length	2.8 ~ 12 mm	
Day/Night	Yes (with removable IR-cut filter)	
Lens Type	Varifocal lens	
Maximum Aperture	F/1.7	
Mount	Ø 14 mm	
Image Format	1/2.7"	
Horizontal FOV	98° ~ 35°	
Operation	Focus	Manual (w/lock)
	Zoom	Manual (w/lock)
	Iris	P-Iris
Max. Torque (Focus/ Zoom Screws)	0.049 N.m	
IR LED Quantity	12 IR LEDs	
Max. IR Distance	30 m (98.4 ft)	
Operation		
Video Compression	H.265, H.264, MJPEG	
Video Stream	Stream 1 from H.265 or H.264 Stream 2 from H.265, H.264 or MJPEG	
Frame Rate	30 fps at 2048 x 1536 (60/50 Hz) * The frame rate and performance may vary depending on the number of connections and data bit-rates (different scenes).	
Image Setting	Brightness, Contrast, Saturation, Sharpness, Gamma, White Balance, Flicker-less, Image Orientation, Shutter Speed, Backlight Compensation, D/N Sensitivity, WDR Pro, Defog, Low Lux Enhancement, Denoise, Metering	

<b>Operation</b>		
Audio Compression		G.711
Audio Support		Two-Way Audio
Sensor Input		1 Input (Dry Contact)
Alarm Output		1 Digital Output (200 mA 5V DC)
<b>Video Resolution</b>		
Main Stream	4 : 3	2048 x 1536 (Default), 1600 x 1200, 1280 x 960, 640 x 480
	16 : 9	1920 x 1080, 1280 x 720, 640 x 360
	5 : 4	1280 x 1024, 640 x 512,
Sub Stream	4 : 3	1024 x 768, 640 x 480 (Default), 320 x 240
	16 : 9	1280 x 720, 640 x 360, 448 x 256
	5 : 4	1280 x 1024, 640 x 512, 320 x 256
<b>Network</b>		
Interface		10/100 Ethernet
Protocol		DHCP, DynDNS, FTP, HTTP, HTTPS, NTP, ONVIF (Profile S), PSIA, QoS (DSCP), RTSP, SNMP, SMTP, TCP, UDP, UPnP, 3GPP/ISMA
<b>Mechanical</b>		
Temperature Detector		Yes
Camera Angle Adjustment	Pan	0° ~ 360°
	Tilt	90° ~ 180°
	Rotate	0° ~ 360°
Connectors	Power	2-pin terminal block, PoE
	Ethernet	Ethernet (10/100 Base-T), RJ-45 Cable
	Audio	1 In (2-pin terminal block for microphone) 1 Out (2-pin terminal block for microphone)
	Digital I/O	4-pin terminal block
Local Storage		Micro SD card slot (SD/SDHC/SDXC/UHS-I, Class 10) *UHS-II card type is not supported.
LED Indicator		2 LEDs: Power, Status
<b>General</b>		
Environment Temperature	Start-up	-20°C ~ 50°C (-4 °F ~ 122 °F)
	Operation	-30°C ~ 50°C (-22 °F ~ 122 °F)
Humidity		10% to 90% (no condensation)
Power Source		12V DC / PoE (IEEE 802.3af)
Max. Power Consumption		12.6 W
Dimensions		215.3 x 91 x 94.4 mm (8.47 x 3.58 x 3.71")
Weight		850 g (1.87 lb)
Ingress Protection		IP67
Vandal Resistance		IK10 for metal casing
Regulatory		CE, FCC, RCM, LVD, RoHS compliant
<b>Power over Ethernet</b>		
PoE Standard		PoE (IEEE 802.3af Power over Ethernet / PD)
PoE Power Supply Type		End-Span
PoE Power Output		Per Port 48V DC, 350 mA. Max. 15.4 watts
<b>Web Interface</b>		
Installation Management		Web-based configuration
Maintenance		Firmware upgrade through Web Browser or Utility
Access from Web Browser		Camera Live View, Video Recording, Change Video Quality, Bandwidth Control, Image Snapshot, Digital I/O Control, Audio, Picture in Picture, Picture and Picture, Privacy Mask, Visual Automation, Tampering Alarm, Text Overlay, Digital PTZ
Language		Arabic / Bulgarian / Czech / Danish / Dutch / English / Finnish / French / German / Greek / Hebrew / Hungarian / Indonesian / Italian / Japanese / Lithuanian / Norwegian / Persian / Polish / Portuguese / Romanian / Russian / Serbian / Simplified Chinese / Slovakian / Slovenian / Spanish / Swedish / Thai / Traditional Chinese / Turkish
<b>Application</b>		
Software Supported		GV-DVR / NVR (V8.7.0.0), GV-VMS (V15.10.1.0), GV-Edge Recording Manager (V1.2.0.0), GV-Center V2 (V15.10.0.0), GV-Recording Server (V1.3.0.0), GV-Redundant / Failover Server (V1.1.0.0)
Smart Device Access		GV-Eye for iOS and Android
Live Viewing		Browser (IE, Chrome, Firefox, Safari), Mobile app
CMS Server support		GV-Control Center, GV-Center V2, GV-Vital Sign Monitor





**Note:**

1. It is required to apply patch files to all the supported software.
2. Mind the following when using an inserted memory card for recording:
  - Recorded data on the memory card can be damaged or lost if the data are accessed while the camera is under physical shock, power interruption, memory card detachment or when the memory card reaches the end of its lifespan. No guarantee is provided for such causes.
  - The stored data can be lost if the memory card is not accessed for a long period of time. Back up your data periodically if you seldom access the memory card.
  - Memory cards are expendable and their durability varies according to the conditions of the installed site and how they are used. Back up your data regularly and replace the memory card annually.
  - To avoid power outage, it is highly suggested to apply a battery backup (UPS).
  - For better performance, it is highly suggested to use Micro SD card of MLC NAND flash, Class 10.
  - Replace the memory card when its read/write speed is lower than 6 MB/s or when the memory card is frequently undetected by the camera.
3. Specifications are subject to change without prior notice.

### Packing List

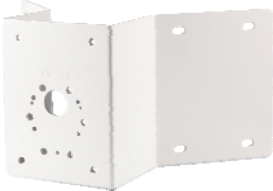
- |                                   |                               |
|-----------------------------------|-------------------------------|
| 1. H.265 Bullet Camera            | 8. Screw for Mounting Kit x 3 |
| 2. Sun-shield Cover               | 9. Nut for Mounting Kit x 3   |
| 3. Screw for Sun-shield Cover x 2 | 10. Hex Wrench                |
| 4. Washer x 2                     | 11. RJ-45 Connector x 2       |
| 5. Screw for Supporting Rack x 3  | 12. GV-IPCAM Software DVD     |
| 6. Screw Anchor x 3               | 13. GV-Software DVD           |
| 7. Silica Gel Bag x 2             | 14. Warranty Card             |

### Accessories

Model No.	Name	Name	Image	Details
GV-Mount300	Convex Corner Adapter Kit		Dimensions: 238.6 x 409.5 mm (9.4" x 16.1") Weight: 4.27 kg (9.41 lb)	
GV-Mount310	Concave Corner Adapter Kit		Dimensions: 123.3 x 393.1 mm (4.9" x 15.5") Weight: 2.96 kg (6.53 lb)	
GV-Mount400	Pole Mount Bracket Kit (Ø 4" ~ 6")		Dimensions Bracket: 241 x 161 mm (9.5" x 6.3") Weight: 1.70 kg ( 3.75 lb) Steel Strap Diameter: Ø 4" ~ 6"	
GV-Mount410	Pole Mount Bracket Kit (Ø 6" ~ 7.5")		Dimensions Bracket: 241 x 161 mm (9.5" x 6.3") Weight: 1.70 kg (3.75 lb) Steel Strap Diameter: Ø 6" ~ 7.5"	
GV-PA191 PoE Adapter	Power over Ethernet (PoE) Adapter		The GV-PA191 is a Power over Ethernet (PoE) adapter designed to provide power to the IP device through a single Ethernet cable.	

GV-Relay V2

GV-Relay V2



The GV-Relay V2 is designed to expand the voltage load of GV IP devices. It provides 4 relay outputs, and each can be set as normally open (NO) or normally closed (NC) independently as per your requirement.

Power Adapter

Contact your sales representative for the countries and areas supported.

GV-POE Switch

The GV-POE Switch is designed to provide power along with network connection for IP devices. The GV-POE Switch is available in various models with different numbers and types of ports.