

## GV-EFD4700 Series 4MP H.265 Super Low Lux WDR Pro IR Mini Fixed IP Dome



- 1/3" progressive scan super low lux CMOS
- Min. illumination at 0.02 lux
- Dual streams from H.265, H.264 and MJPEG
- Up to 20 fps at 2592 x 1520, 25 fps at 2560 x 1440, 30 fps at 2048 x 1520
- Intelligent IR
- Day and Night function (with removable IR-cut filter)
- 2-axis mechanism (pan / tilt)
- Built-in microphone
- Wide Dynamic Range Pro (WDR Pro)
- 3D noise reduction
- Smart streaming
- Defog
- Motion detection
- Tampering alarm
- Text overlay
- Privacy mask
- IP address filtering
- DC 12V / PoE (IEEE 802.3af)
- Megapixel lens
- Recording assigned by GV-Edge Recording Manager (Windows & Mac)
- Supports iPhone, iPad, Android & 3GPP
- 31 languages on Web interface
- ONVIF (Profile S) conformant
- \* Smart streaming requires either GV-DVR / NVR V8.7.0.0 or GV-VMS V16.10.3

### Introduction

The Target Mini Fixed Dome is an indoor, fixed, mini-sized network camera equipped with an automatic IR-cut filter and IR LEDs for day and night surveillance. Adjustable in 2 axis (pan and tilt), it offers an entry-level surveillance solution with all the essential features and excellent image quality. GV-EFD4700 supports H.265 video codec to achieve better compression ratio while maintaining high quality pictures at reduced network bandwidths. With the super low lux CMOS image sensor, the camera is capable of providing a color live view in near darkness.

### Models

Model	Iris	Focal Length (mm)	Maximum Aperture	Image Format
GV-EFD4700-0F	Fixed	2.8	F/2.0	1/2.7"
GV-EFD4700-2F	Fixed	3.8	F/1.8	1/2.7"

### Active Tampering Alarm

Tampered



Focus Change



Camera Shift

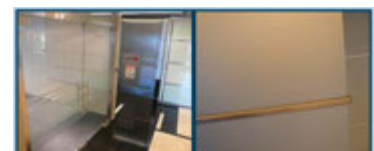

## Dimensions

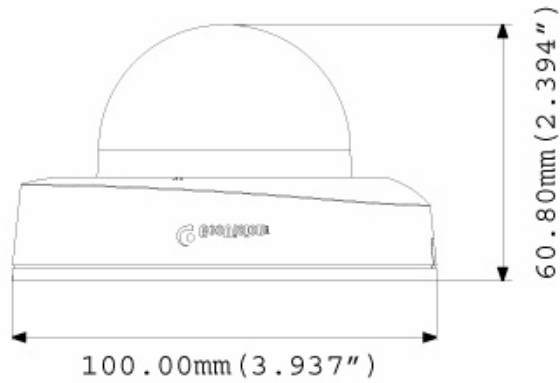

## Specifications

Camera		GV-EFD4700-0F	GV-EFD4700-2F
Image Sensor		1/3" progressive scan super low lux CMOS	
Picture Elements		2560 (H) x 1440 (V)	
Minimum Illumination	Color	0.03 Lux	
	B/W	0.02 Lux	
	IR ON	0 Lux	
Shutter Speed		Automatic, manual (1/5 ~ 1/8000 sec.)	
White Balance		Automatic, manual (2800K ~ 8500K)	
Gain Control		Automatic	
S/N Ratio		50 dB	
WDR		WDR Pro	
Dynamic Range		Up to 120 dB	
<b>Lens</b>			
Megapixel		Yes	
Day/Night		Yes (with removable IR-cut filter)	
Focal Length		2.8 mm	3.8 mm
Lens Type		Fixed	
Maximum Aperture		F/2.0	F/1.8
Mount		M12, Pitch 0.5 mm	
Horizontal FOV		96°	72°
Image Format		1/2.7"	
Operation	Focus	Fixed	
	Zoom	Fixed	
	Iris	Fixed	
IR LED Quantity		12 IR LEDs	
Max. IR Distance		15 m (50 ft)	
<b>Operation</b>			
Video Compression		H.265, H.264, MJPEG	
Video Streaming		Stream 1 from H.265 or H.264 Stream 2 from H.265, H.264 or MJPEG	
Frame Rate		50 Hz: 20 fps at 2592 x 1520, 25 fps at 2560 x 1440, 25 fps at 2048 x 1520 60 Hz: 20 fps at 2592 x 1520, 24 fps at 2560 x 1440, 30 fps at 2048 x 1520 * The frame rate and performance may vary depending on the number of connections and data bitrates (different scenes).	
Image Setting		Brightness, Contrast, Saturation, Sharpness, Gamma, White Balance, Flicker-less, Image Orientation, Shutter Speed, Backlight Compensation, D/N Sensitivity, WDR, Defog, Low Lux Enhancement, Denoise, Metering	
Audio Compression		G.711	
Audio Support		One-way audio	

Video Resolution		
Main Stream	4:3	2048 x 1520, 1600 x 1200, 1280 x 960, 640 x 480
	16:9	2592 x 1520, 2560 x 1440 (Default) , 2304 x 1296, 1920 x 1080, 1280 x 720, 640 x 360
	5:4	1280 x 1024, 640 x 512
Sub Stream	4:3	1024 x 768, 640 x 480, 320 x 240
	16:9	1280 x 720, 640 x 360 (Default) , 448 x 256
	5:4	1280 x 1024, 640 x 512, 320 x 256
Network		
Interface	10/100 Ethernet	
Ethernet Protocol	DHCP, DynDNS, FTP, HTTP, HTTPS, NTP, ONVIF (Profile S), QoS (DSCP), RTSP, SNMP, SMTP, TCP, UDP, UPnP, 3GPP/ISMA	
Mechanical		
Temperature Detector	Yes	
Camera Angle Adjustment	Pan	-45° ~ 45°
	Tilt	0° ~ 63°
Connectors	Power	2-pin terminal block, PoE
	Ethernet	Ethernet (10/100 Base-T), RJ-45 cable
	Audio	1 In (built-in microphone)
LED Indicator	4 LEDs: Link, ACT, Power, Status	
General		
Environment Temperature	0 °C ~ 45 °C (32 °F ~ 113 °F)	
Humidity	10% to 90% (no condensation)	
Power Source	12V DC/PoE (IEEE 802.3af)	
Max. Power Consumption	6.07 W	
Dimension	ø 100 x 60 mm (3.9" x 2.4")	
Weight	148 g (0.33 lb)	
Regulatory	CE, FCC, RCM, LVD, RoHS compliant	
Power over Ethernet		
PoE Standard	PoE (IEEE 802.3af Power over Ethernet / PD)	
PoE Power Supply Type	End-span and Mid-span	
PoE Power Output	Per Port 48V DC, 350 mA, Max. 15.4 watts	
Web Interface		
Installation Management	Web-based configuration	
Maintenance	Firmware upgrade through Web Browser or Utility	
Access from Web Browser	Camera Live View, Video Recording, Change Video Quality, Bandwidth Control, Image Snapshot, Audio, Picture in Picture, Picture and Picture, Privacy Mask, Text Overlay, Digital PTZ	
Language	Arabic / Bulgarian / Czech / Danish / Dutch / English / Finnish / French / German / Greek / Hebrew / Hungarian / Indonesian / Italian / Japanese / Lithuanian / Norwegian / Persian / Polish / Portuguese / Romanian / Russian / Serbian / Simplified Chinese / Slovakian / Slovenian / Spanish / Swedish / Thai / Traditional Chinese / Turkish	
Applications		
Software Supported	GV-DVR / NVR (V8.7.1.0), GV-VMS (V15.11.1.0), GV-Edge Recording Manager (V1.2.0.0), GV-Center V2 (V15.10.0.0), GV-Recording Server (V1.3.0.0), GV-Redundant / Failover Server (V1.1.0.0)	
Smart Device Access	GV-Eye for iOS and Android	
Live Viewing	Browser (IE, Chrome, Firefox, Safari), Mobile App	
CMS Server support	GV-Control Center, GV-Center V2, GV-Vital Sign Monitor	

**Note:**





1. Specifications are subject to change without prior notice.
2. It is required to apply patch files to all the supported software.

## Packing List

- |                          |                          |
|--------------------------|--------------------------|
| 1. H.265 Mini Fixed Dome | 5. GV-IPCAM Software DVD |
| 2. Screw x 2             | 6. GV-Software DVD       |
| 3. Screw Anchor x 2      | 7. Warranty Card         |
| 4. Focus Adjustment Ring |                          |

**Note:** Power adapters can be purchased upon request.

## Accessories

Model No./Name	Details
<b>GV-Mount900 Wall Mount Bracket</b> 	Dimensions: 154 x 108 x 50 mm (6.1" x 4.3" x 2") Weight: 240 g (0.53 lb)
<b>GV-Mount910 Power Box Mount Bracket</b> 	Dimensions: 112 x 98 x 7.5 mm (4.4" x 3.9" x 0.3") Weight: 105 g (0.23 lb)
<b>GV-Mount913 Power Box Mount Bracket</b> 	Dimensions: $\varnothing$ 146 x 7.5 mm ( $\varnothing$ 5.7" x 0.3") Weight: 180 g (0.4 lb)
<b>GV-Mount918 Wall Mount Bracket for MFD/MDR/efd/EDR</b> 	Dimensions: $\varnothing$ 145 x 117 x 96 mm ( $\varnothing$ 5.71 x 4.60 x 3.78") Weight: 350 g (0.77 lb)
<b>GV-PA191 PoE Adapter</b> 	Dimensions (H x W x D): 43 x 69 x 40 mm (1.69" x 2.72" x 1.57") Weight: 130 g (0.29 lb)
<b>Power Adapter</b>	Contact your sales representative for the countries and areas supported.
<b>GV-POE Switch</b>	The GV-POE Switch is designed to provide power along with network connection for IP devices. The GV-POE Switch is available in various models with different numbers and types of ports.